

# Montage Plissé standaard

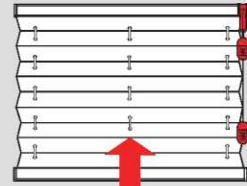

## Bediening / Operation / Utilisation - plissé top-down

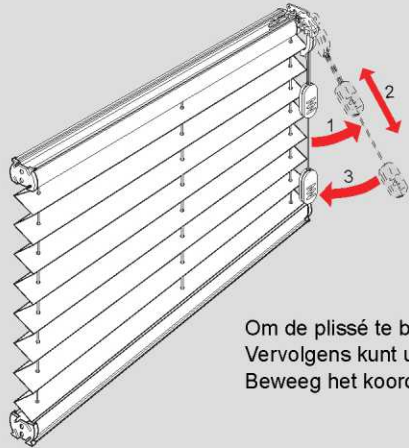

onderzijde

Om de plissé te bedienen, brengt u het koord in een hoek naar voren (1). Vervolgens kunt u het koord laten vieren of naar beneden trekken (2). Beweeg het koord richting plissé om tekeren op de gewenste hoogte (3).

## Veiligheidsvoorschrift / Safety / Sécurité

Neem dit veiligheidsvoorschrift a.u.b. in acht: Voor uw veiligheid!  
For your own safety: Please follow the safety instructions!  
Veuillez respecter la consigne de sécurité: Pour votre sécurité!

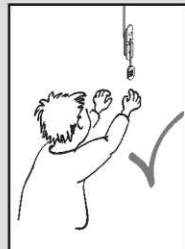
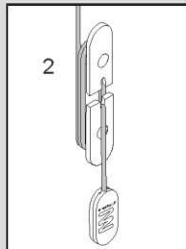
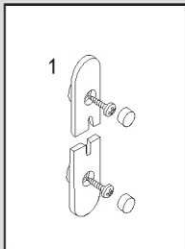
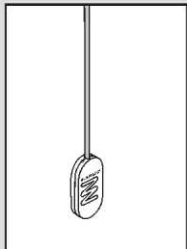

## Bovenzijde montage Top x mounting

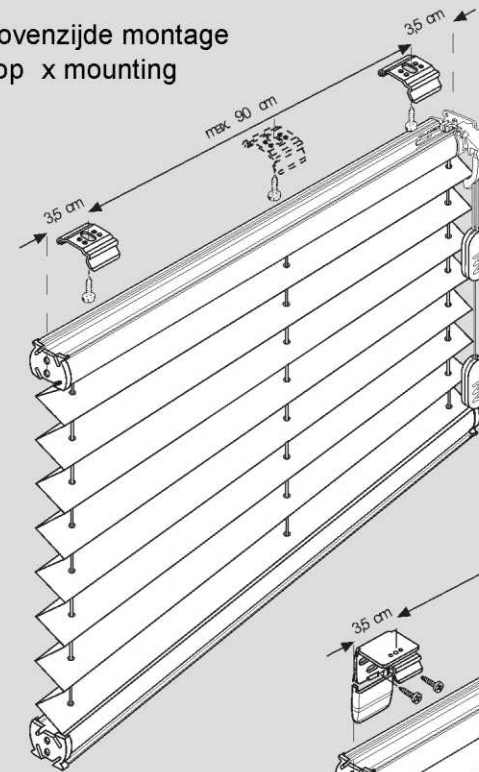

Monteer beugels aan de uiteinden met het schroefgat op 3,5 cm vanaf de zijde van de plissé. Tussen twee beugels mag max. 90cm ruimte zitten.

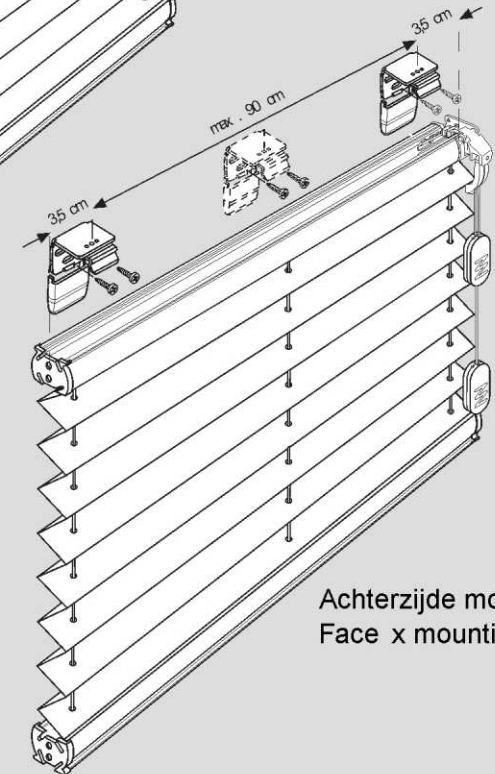

Achterzijde montage  
Face x mounting

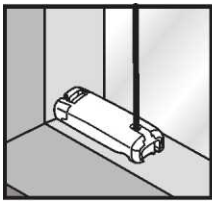

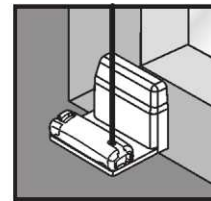

Bevestiging in de sponning (in-beugel)  
Top xing  
Dans la feuillure



Bevestiging met hoeksteun (op-beugel)  
Face xing  
Avec equerre de xation



Montage / Fitting / Montage

Plissé  Honingraatstof 

**1** 17 mm  
5 mm  
5 mm  
5 mm  
15 mm  
17 mm

**1** 19 mm  
5 mm  
5 mm  
5 mm  
15 mm  
19 mm

**2** **3** **4** **5**



**6** **7** **8** **9**

**10**

Demontage / Disassembly / Demontage

**1** **2** **3**

Montage / Fitting / Montage

Plissé  & Honingraatstof 

**1** **2**

Uitlijning beugel met onderrail plissé

**3** **4** **5** **6** **7**

**8** **9** **10** **11** **12**

**13**

Demontage / Disassembly / Demontage

**1** **2** **3**

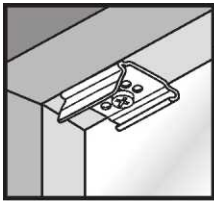

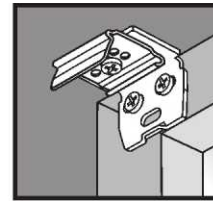

Bovenzijde montage  
(in vensternis / in de dag)  
Top x mounting  
Dans la feuillure



Achterzijde montage  
(op vensternis / op de dag)  
Face x mounting  
Avec equerre de xation



Montage  
Fitting  
Montage

Positie schroefgat bij: Plissé  Honingraatstof 

1

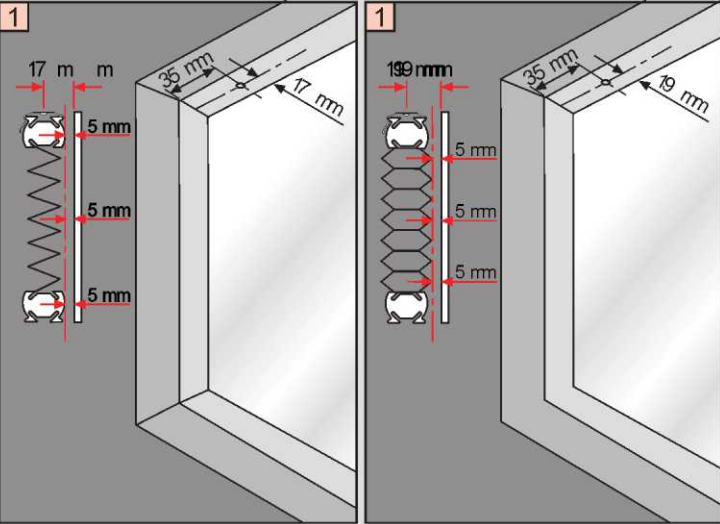

2

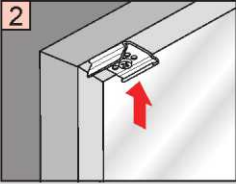

3

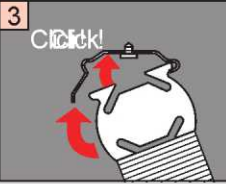

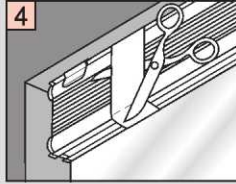

4

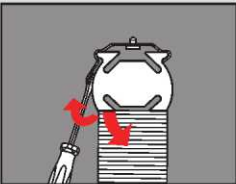

Demontage / Disassembly / Demontage



Montage  
Fitting  
Montage

Plissé  & Honingraatstof 

1

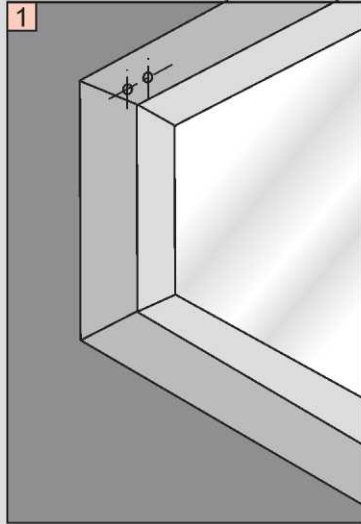

2

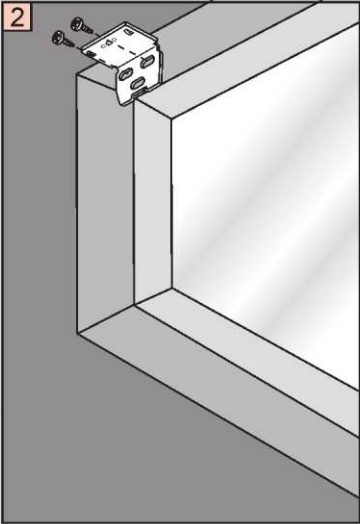

3

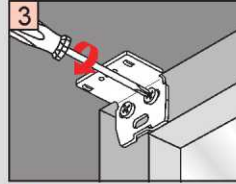

4

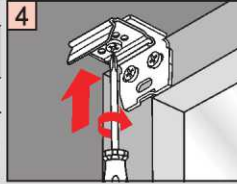

5

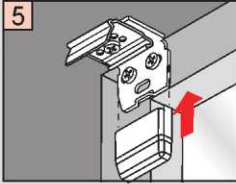

6

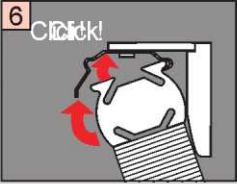

7

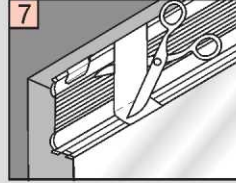

Demontage / Disassembly / Demontage

